



# Advanced Heating and Hot Water Systems



**P H O E N I X<sup>®</sup>**

**96% Efficient Commercial and Residential Hot Water Heaters**

# HTP DOES IT BEST

Manufactured by HTP, Inc., a company with over 20 years experience using condensing water heating

316L Stainless Steel Tanks are built to withstand high temperatures and have superior corrosion resistance, which extends the life of the unit.

Internal hybrid cupronickel/stainless steel heat exchanger provides exceptional heat transfer capabilities

Eliminates the use of anode rods that require costly maintenance and may cause the water to have an unpleasant taste and smell

Fully modulating condensing unit with up to a 5-1 turndown ratio. This reduces cycling and conserves energy while meeting desired heating needs

Ease of installation with a lightweight design ranging from 175-405 LBS

**PHOENIX Water Heater**      **Traditional Water Heater Manufacturing Companies**

	
	
	
	
	
	

Why choose any other high efficiency condensing water heater...

*Phoenix does it all!*



## PHOENIX® EFFICIENCY

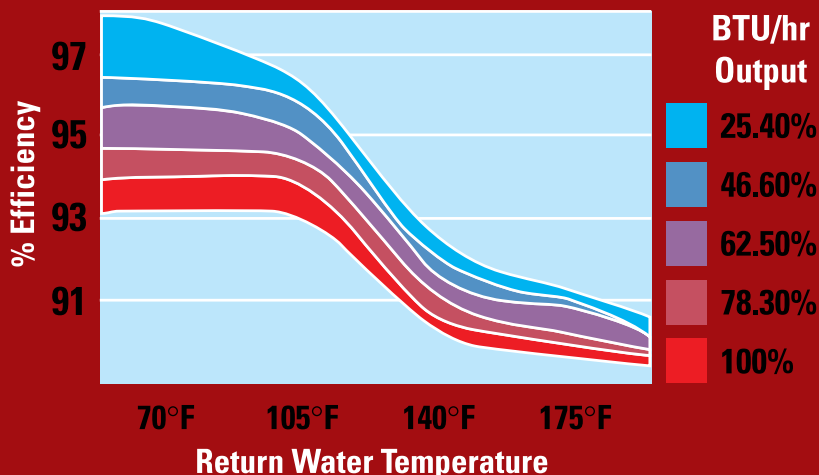

The Phoenix® electronic control adjusts the burner firing rate to match demand. The burner firing rate increases as the demand increases and decreases as the hot water demand approaches the required temperature set point. This load matching modulation dramatically reduces on/off cycling, resulting in longer component life, reliability and higher system efficiency.

**PHOENIX APPLICATIONS:** Fan coil • DHW • Solar version • Sanitation (Models: PH130-55SA & PH199-55SA) • Retro fit • Co-generation heat recovery • Buffer tank

# Phoenix Gas Fired Water Heater Dimensions and Specifications

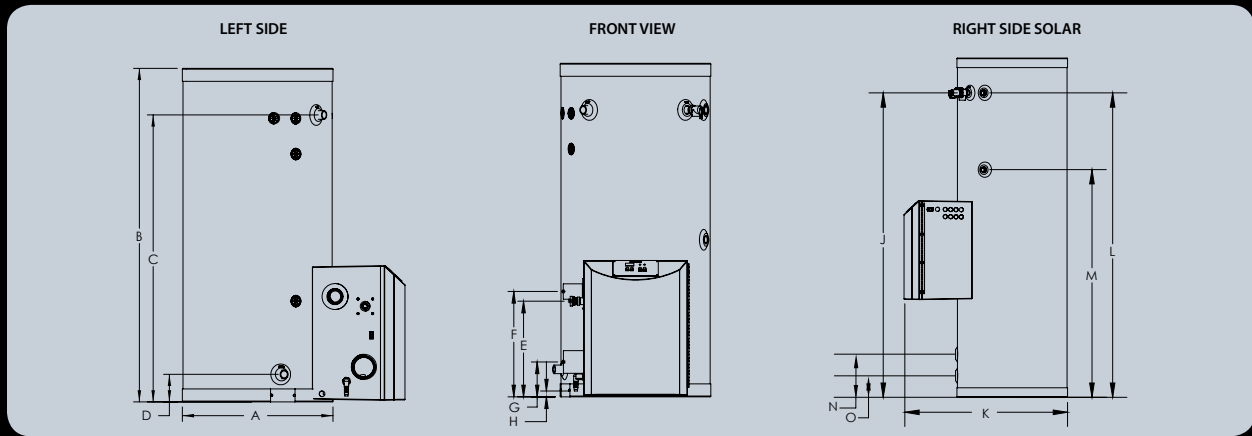

## PHOENIX WATER HEATER AND SANITIZER BOOSTER DIMENSIONS

	MODEL	GAL.	A	B	C	D	E	F	G	H	J	K	L	M		
	PH100-55/ PH130-55 PH160-55/ PH199-55	55	23"	52"	45"	5"	14-3/4"	16-1/4"	5-1/4"	1"	45"	34-1/4"	45"	27-1/2"		
	PH100-80/ PH130-80 PH160-80/ PH199-80	80	23"	72"	64"	5"	17"	18-1/2"	7-3/4"	3-1/4"	64"	34-1/4"	64"	29-3/4"		
	PH100-119/ PH130-119 PH160-119/ PH199-119	119	27"	74"	66-1/4"	7-1/2"	18-3/4"	21-1/2"	10-1/2"	5"	66-1/2"	38-1/2"	66-1/2"	31"		
	PH130-55SA/ PH199-55SA	55	23"	52"	45"	5"	14-3/4"	16-1/4"	5-1/4"	1"	45"	34-1/4"	45"	27-1/2"		

## PHOENIX SOLAR WATER HEATER DIMENSIONS

SRCC SYSTEM AVAILABLE	MODEL	GAL.	A	B	C	D	E	F	G	H	J	K	L	M	N	O
PH-80S	PH130-80S/ PH199-80S	80	23"	72"	65"	5-3/4"	36"	37-1/2"	27"	22-1/2"	64-3/4"	34"	64-3/4"	48-3/4"	9-3/4"	5-1/4"
PH-119S	PH130-119S/ PH199-119S	119	27"	74"	66"	7-1/4"	36-3/4"	38-1/4"	27-1/4"	23-1/4"	66-1/4"	38-1/4"	66-1/4"	49-1/4"	11-1/2"	7"

## PHOENIX WATER HEATER AND SANITIZER BOOSTER SPECIFICATIONS

MODEL	BTU's	AIR INTAKE/ EXHAUST VENT SIZE	INLET/ OUTLET SIZE	AUXILIARY CONN.	GAS LINE CONN.	SYSTEM RELIEF PIPE SIZE	SHIPPING WEIGHT	MAX. TEMPERATURE LIMIT
PH100-55	100,000	2"	1" NPT	1" FNPT	3/4"	3/4"	175 LBS	160 F
PH130-55	130,000	2"	1" NPT	1" FNPT	3/4"	3/4"	175 LBS	160 F
PH160-55	160,000	3"	1" NPT	1" FNPT	3/4"	3/4"	175 LBS	160 F
PH199-55	199,000	3"	1" NPT	1" FNPT	3/4"	3/4"	175 LBS	160 F
PH100-80	100,000	2"	1-1/2" NPT	1" FNPT	3/4"	3/4"	235 LBS	160 F
PH130-80	130,000	2"	1-1/2" NPT	1" FNPT	3/4"	3/4"	235 LBS	160 F
PH160-80	160,000	3"	1-1/2" NPT	1" FNPT	3/4"	3/4"	235 LBS	160 F
PH199-80	199,000	3"	1-1/2" NPT	1" FNPT	3/4"	3/4"	235 LBS	160 F
PH100-119	100,000	2"	1-1/2" NPT	1" FNPT	3/4"	3/4"	405 LBS	160 F
PH130-119	130,000	2"	1-1/2" NPT	1" FNPT	3/4"	3/4"	405 LBS	160 F
PH160-119	160,000	3"	1-1/2" NPT	1" FNPT	3/4"	3/4"	405 LBS	160 F
PH199-119	199,000	3"	1-1/2" NPT	1" FNPT	3/4"	3/4"	405 LBS	160 F
PH130-55SA	130,000	2"	1" NPT	1" FNPT	3/4"	3/4"	175 LBS	184 F
PH199-55SA	199,000	3"	1" NPT	1" FNPT	3/4"	3/4"	175 LBS	184 F

### STANDARD FEATURES

- Up to 96% Thermal Efficiency
- Modulating Bumer
- 5:1 Turndown Ratio
- Vents in PVC, CPVC, Stainless Steel, ULC S636
- Limited Warranty
- 7 Year Residential
- 3 Year Commercial

### WHAT'S IN THE BOX

- Intake PVC Tee w/ Screens
- Exhaust PVC Coupling w/ Screens
- Installation Manual
- Solar Addendum (Solar Models Only)
- LP Conversion Kit (Natural Gas Models Only)

### OPTIONAL EQUIPMENT

- Outdoor Sensor
- 2", 3" PVC Concentric Vent Kit
- 3", 4" Stainless Steel Outside Termination Vent Kit
- Condensate Neutralizer
- PC Connection Cable w/ Software
- Sanitizer Booster Kit

## PHOENIX SOLAR WATER HEATER SPECIFICATIONS

SRCC SYSTEM AVAILABLE	MODEL	BTU's.	AIR INTAKE/ EXHAUST VENT SIZE	INLET/ OUTLET SIZE	AUXILIARY CONN.	GAS LINE CONN.	SYSTEM RELIEF PIPE SIZE	SHIPPING WEIGHT	MAX. TEMPERATURE LIMIT
PH-80S	PH130-80S PH130-119S	130,000	2"	1" NPT	1"	3/4"	3/4"	245 LBS	160 F
PH-119S	PH199-80S PH199-119S	199,000	3"	1" NPT	1"	3/4"	3/4"	415 LBS	160 F

Note: All units are compatible with natural gas or liquid propane, but must be specified upon placing an order.



# One Highly Efficient Unit

## Residential

The Phoenix provides an abundance of hot water for large residential applications with multiple bathrooms, whirlpools, dishwashers, washers and more. Forget about taking another cold shower!



**96% Maximum Thermal Efficiency**

**Up to 5:1 Turndown Ratio**

**316L Stainless Steel Tank**

**No Need for Anode Rods**

**Hybrid 90/10 Cupronickel/  
Stainless Steel Heat Exchanger**

**Combined Vent Length of  
Up to 200 Feet**

## Commercial

Perfect for high demand applications including apartment buildings, restaurants, hotels, schools, hospitals, laundry facilities, office buildings and other commercial jobs.



**Load Matched Modulating Burner  
for Maximum Fuel Efficiency**

**Exceeds All Low NOx Emission  
Standards**

**Whisper Quiet: 50dB at 5ft.**

**Single Vent and Gas Connection**

**Virtually Maintenance Free**

**Low Standby Heat Loss**



**4 Different  
BTU Outputs  
Available**

**3 Tank Sizes  
To Choose  
From**

MODEL	INPUT MODULATION	FIRST HR. RATING	100 DEG. F. RISE	THERMAL EFFICIENCY
PH100-55	35,000-100,000	169 GAL.	115	94.8%
PH130-55	35,000-130,000	205 GAL.	148	93.7%
PH160-55	40,000- 160,000	245 GAL.	184	95.1%
PH199-55	40,000-199,000	295 GAL.	229	95.0%
PH100-80	35,000-100,000	189 GAL.	116	95.8%
PH130-80	35,000-130,000	227 GAL.	150	95.4%
PH160-80	40,000-160,000	265 GAL.	184	95.2%
PH199-80	40,000-199,000	314 GAL.	229	94.8%
PH100-119	35,000-100,000	214 GAL.	117	96.3%
PH130-119	35,000-130,000	257 GAL.	152	96.1%
PH160-119	40,000-160,000	295 GAL.	184	96.1%
PH199-119	40,000-199,000	335 GAL.	230	96.1%

**See payback  
after only a  
few years of  
operation!**

# A Closer Look At HTP's Phoenix Gas Fired Water Heater

Low Water Cutoff Sensor assures that the tank will not operate unless it is filled with water

High Limit Safety

Upper Temperature Sensor accurately measures temperatures to control burner input

Attractive Silver Finish Cover resists dents and corrosion

Lower Temperature Sensor accurately measures temperature to control burner input

Cold Water Inlet bottom feed cold water to help remove sediment from bottom of the tank

Exhaust Adaptor to PVC/ CPVC Venting

Hot Water Outlet dip tube draws all the hot water from the top of the tank near the dome to improve the amount of hot water delivered

Temperature and Pressure Relief Valve

Combustion Heat Exchanger Stainless Steel/Cupronickel

Tank Constructed of 316L Stainless Steel

2" Foam Insulation 1/2 degree per hour heat loss

Digital Display system monitoring and temperature adjustment

Air Intake to PVC/ CPVC Venting

Condensate Trap Assembly

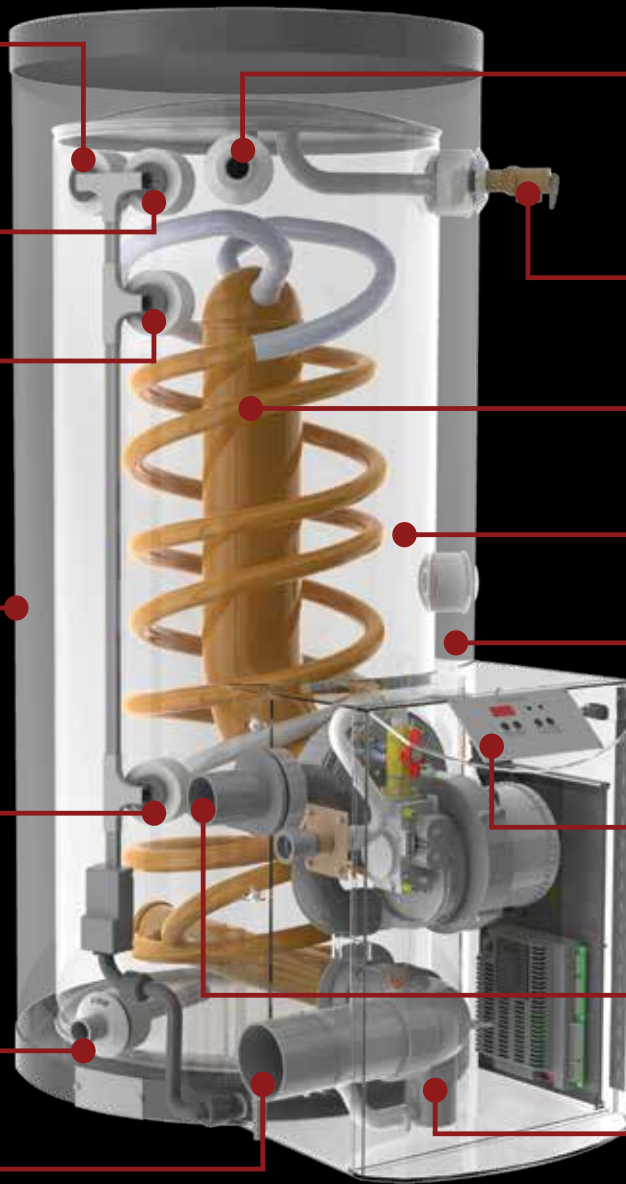



# For All Your Heating Needs

## Solar

Harness the power of the sun...Phoenix Solar Water Heaters are the first modulating condensing solar water heaters with an integrated gas fired back-up all in one unit!

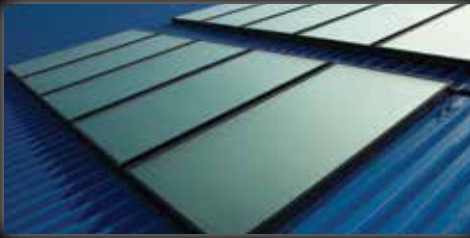

HTP has everything for your solar needs



**Tanks**

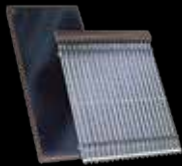

**Panels**



**Controls**



**Line Sets**

## Sanitizer

The Phoenix line offers a high temp sanitation tank for those need to be clean applications. Great for use in restaurants, breweries, wineries, dairies and more.



Maximum Operating Temperature of 184 Degrees F.

Ideal for Commercial applications including:

- Dishwashers
- Sterilizing Tools
- Cleaning and Disinfecting Equipment



MODEL	INPUT MODULATION	FIRST HR. RATING
PH130-80S	35,000-130,000	227 GPH
PH199-80S	40,000-199,000	314 GPH
PH130-119S	35,000-130,000	257 GPH
PH199-119S	66,000-199,000	335 GPH
PH130-119SNHX	35,000-130,000	257 GPH
PH199-119SNHX	66,000-199,000	335 GPH

MODEL	INPUT MODULATION	FIRST HR. RATING	THERMAL EFFICIENCY
PH130-55SA	35,000-130,000	205 GAL.	93.7%
PH199-55SA	40,000-199,000	295 GAL.	95.0%

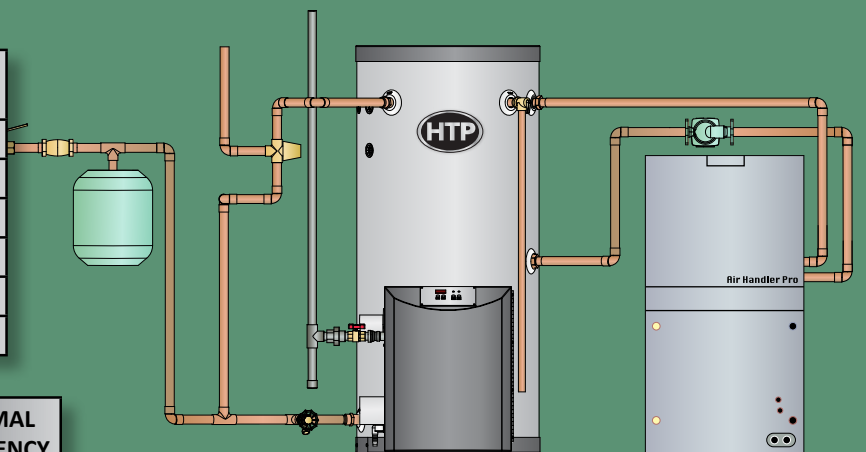

Combining the Phoenix with an Air Handler  
A Unique and Highly Efficient Way to Provide Heat and Hot Water